

# DESIGNFORM™



14' x 10' DesignForm™ OPTIMA colonial in almond (left), paired with a Raynor Innovations Series™ 16' x 8' Affina™ colonial in almond.

S T Y L I S H

R E L I A B L E

D U R A B L E

**RAYNOR®**

Click: [www.raynor.com](http://www.raynor.com)  
Call: 1-800-4-RAYNOR

# DESIGNFORM™

## SECTIONAL RAISED PANEL DOORS

When your building's façade needs a classic raised panel design, choose from DesignForm™ doors. With style choices, like mixed panel designs and safety features including finger-protection, DesignForm™ doors offer the aesthetic options of a residential door; combined with the durability of a commercial door. Matches Innovations Series™ residential doors.

## DESIGNFORM™ OPTIMA

A perfect commercial-sized companion for the residential Centura™ doors, this full 2", R-18 door will brighten up the appearance of any building, inside and out. Available in a wide range of colors, the DesignForm™ OPTIMA is your best choice for an over-sized, classic residential appearance.

## DESIGNFORM™ STANDARD

This 1 3/8", R-13.08 door is perfect for the RV or boat storage garage and matches the Colonial, Ranch or Flush look of the residential Innovations Relante™ doors. Available in White, Almond or ClayTone.



12' x 14' DesignForm™ STANDARD colonial in ClayTone with clear colonial windows (center), flanked by matching 9' x 8' Raynor Innovations Series™ Relante™ doors.

Series MODEL	Max. Opening Width	Max. Opening Height	Construction	Panel Configuration	Section Thickness	End/Center Stile Steel Thickness	Insulation (R-Value)	Thermal Break	Exterior Colors	Section Warranty
DesignForm™ OPTIMA	20'	16'	Steel Sandwich (24-gauge embossed)	Colonial Ranch Mixed Flush (Woodgrain)	2"	18-Gauge/ 19-Gauge Plates	Polyurethane R=18.0	Yes	White, Almond, ClayTone, GrayTone, Dark Brown*, Hunter Green*	1-Year (Rust)
DesignForm™ STANDARD	20'	16'	Steel Sandwich (24-gauge embossed)	Colonial Ranch Flush (Woodgrain)	1 3/8"	20-Gauge/ 19-Gauge Plates	Polyurethane R=13.08	Yes	White, Almond, ClayTone	1-Year (Rust)

\*Features the Kynar™ paint process, which provides extended UV protection against fading.

**WARRANTY** DesignForm™ door sections carry a 1-year warranty against rust and a 1-year limited warranty against any defects in materials or workmanship. See your local Raynor Dealer for complete details.

## DESIGNFORM™ FEATURES

### DURABLE DOOR SECTIONS



Raynor DesignForm™ sections are constructed from hot-dipped galvanized steel and coated with a baked-on, fade-resistant polyester finish for maximum durability, rust-resistance and color retention.

### ENERGY-SAVING INSULATION



Our state-of-the-art polyurethane insulation (shown) gives DesignForm™ OPTIMA and STANDARD doors the industry's highest R-values.

### RAYNOR FINGER PROTECTION SYSTEM™



As your garage door closes, the exclusive Raynor Finger Protection System™ gently pushes fingers away from section joints and out of harm's way.

### CUSTOM-FIT TRACK



All Raynor custom-fit track is constructed from heavy-gauge steel for maximum stability and long life. Made specifically to order, our track is adjustable so your door always fits perfectly against your door opening, preventing energy loss.

### DesignForm™ OPTIMA

- 2" Thick (Steel two-Sided)
- R-Value 18.0

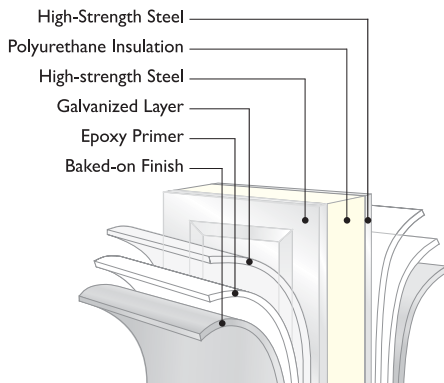

### DesignForm™ STANDARD

- 1 3/8" Thick (Steel two-Sided)
- R-Value 13.08

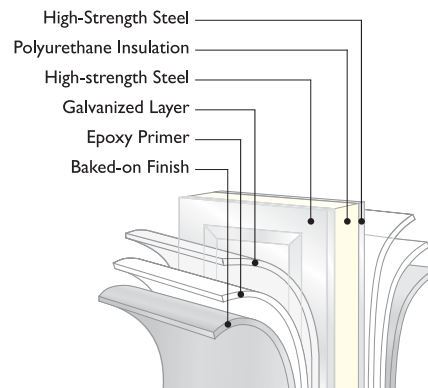

## DESIGNFORM™ PANEL CONFIGURATIONS

### STANDARD DESIGNS

#### COLONIAL

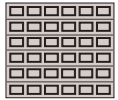

9'0" — 10'6" Height  
10'4" — 13'6" Width

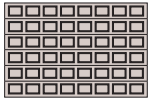

9'0" — 10'6" Height  
13'7" — 20'0" Width

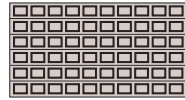

9'0" — 10'6" Height  
19'6" — 20'0" Width

#### RANCH



9'0" — 10'6" Height  
10'4" — 13'6" Width



9'0" — 10'6" Height  
13'7" — 19'5" Width



9'0" — 10'6" Height  
19'6" — 20'0" Width

#### FLUSH

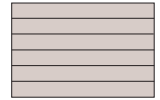

9'0" — 10'6" Height  
4'0" — 20'0" Width

### OPTIONAL DESIGNS

Note: Optional designs available only with DesignForm™ OPTIMA.

#### EDGEWATER

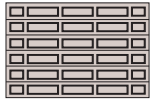

9'0" — 10'6" Height  
13'7" — 19'5" Width

#### BROOKVIEW

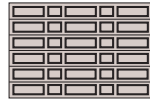

9'0" — 10'6" Height  
13'7" — 19'5" Width

#### RIVERSIDE

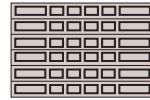

9'0" — 10'6" Height  
13'7" — 19'5" Width

#### BRIDGEPORT

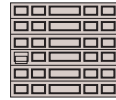

9'0" — 10'6" Height  
10'4" — 13'6" Width

#### MILLCREEK



9'0" — 10'6" Height  
7'0" — 10'3" Width

#### SPRINGFIELD

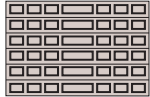

9'0" — 10'6" Height  
13'7" — 19'5" Width

#### SHORELAND

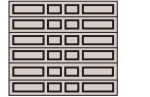

9'0" — 10'6" Height  
13'7" — 19'5" Width

#### BAYPOINT

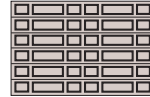

9'0" — 10'6" Height  
13'7" — 19'5" Width

#### RIDGELAKE

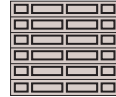

9'0" — 10'6" Height  
10'4" — 13'6" Width

#### HIGHCREST



9'0" — 10'6" Height  
13'7" — 19'5" Width

Illustrations represent doors from 9'0" - 10'6" high. Ask your Raynor Dealer for specific size availability for each design.

### COLORS

See chart (left) for color availability on models.

#### Standard



White



ClayTone



Almond

#### Optional



GrayTone

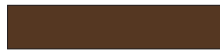

Dark Brown\*



Hunter Green\*

\*Features the Kynar® paint process, which provides extended UV protection against fading.

### APPLICATION GUIDE

	DesignForm™ OPTIMA	DesignForm™ STANDARD
<i>Residential look in a commercial application</i>		
Heated	●	○
Unheated	○	●
<i>Oversize Motor Home garage in a residential application</i>		
Heated	●	○
Unheated	○	●
<i>"Suburban" out buildings</i>		
Heated	●	○
Unheated	○	●
Restaurant	●	○
Fire Station/EMT	●	○
High Cycle Parking Garage	●	●

● Best Choice   ○ Good Solution   ○ Applicable



Visit us at [www.raynor.com](http://www.raynor.com) for  
CSI Master Format™ specifications,  
Raynor Quick Specs  
and Standard Drawings

DESIGNFORM™ WINDOW OPTIONS

**DIMENSIONS™**

Dimensions™ leaded and beveled-style windows add unmatched character to your door. Translucent designs illuminate your garage interior, while maintaining privacy.

**Acrylic Leaded And Beveled**

Create the appearance of authentic leaded and beveled windows with these four stunning acrylic designs.



Antique Brass Ranch



Antique Charcoal Ranch



Regency Brass Colonial



Expressions Brass Colonial

**Frosted Leaded Glass**

Frosted leaded glass styles give you soft, diffused light and more privacy.



Diamond Colonial



Diamond Ranch



Ovals & Diamonds Ranch

**Frosted Beveled Glass**

The bevel designs in these frosted glass windows create a subtle elegance.



Sunrise Colonial



Sunrise Ranch



Pinnacle Colonial



Pinnacle Ranch

**Silkscreen Styles**

Give your door a touch of sophistication with Raynor silkscreen window designs. Enjoy the divided light that radiates through these split window patterns.



Sherwood Colonial



Sunburst Ranch



Cathedral Colonial

**Snap-in Styles**

Snap-in window designs add charm. Choose from a variety of colors to match your garage door or paint them to complement the exterior facade.



Sunburst Colonial



Sunburst Ranch



Stockton Colonial



Stockton Ranch



Cascade Colonial



Cascade Ranch



Sherwood Colonial



Cathedral Colonial



Sunray Ranch

**Clear and Obscure**



Clear Colonial



Clear Ranch



Obscure Colonial



Obscure Ranch

Note: Windows are shown in one-car configurations, with the exception of Sunray Ranch.

Match your door with one of our many operators. Choose from our full line of powerful commercial operators for maximum performance in a commercial setting. Or, for compliance in residential applications, opt for PowerHoist™ SELECT, the perfect choice for DesignForm™ doors up to 14 feet high.

# CONTROLHOIST™

Raynor ControlHoist™ operators with solid state logic board control are available in various motor and voltage combinations to meet many commercial applications.

## O P E R A T O R S

Series MODEL	Operation Mode	Duty Cycle	Drive	Environmental Options (NEMA)	Motor	Logic	Power	Brake	Wiring Options	Warranty
ControlHoist™ OPTIMA	Trolley or Jackshaft	30/hr	Gear	NEMA I	Continuous Duty 1/2hp	Solid State	Trolley 115V, 230V-3 Jackshaft 115V, 230V-3	Solenoid Type	24V Class 2, On-board Selection	2-Years
ControlHoist™ STANDARD	Trolley or Jackshaft	30/hr	Belt	NEMA I	Continuous Duty 1/3 or 1/2hp	Solid State	Trolley 115V Jackshaft 115V	Jackshaft-Optional	24V Class 2, On-board Selection	2-Years
ControlHoist™ BASIC	Trolley or Jackshaft	10/hr	Belt	NEMA I	Intermittent Duty 1/2hp	Solid State	115V	Included on Jackshaft, Optional on Trolley	24V Class 2	2-Years
ControlHoist™ SELECT*	Trolley	8/hr	Gear/Chain	NEMA I	Intermittent Duty 1/2hp	Solid State	115V	Gear Reduction	Single-Button	1-Year

\*Compliant for use in residential applications.

# POWERHOIST™

Rugged Raynor PowerHoist™ operators are available in a variety of motor, voltage and phase combinations for any commercial or industrial application.

## O P E R A T O R S

Series MODEL	Operation Mode	Duty Cycle	Drive	Environmental Options (NEMA)	Motor	Logic	Power	Brake	Hand Chain (Jackshaft Only)	Warranty
PowerHoist™ OPTIMA	Jackshaft or Trolley	30/hr	Gear	1-Standard 4-Water 7-Explosion 9-Explosion 12-Dust	Continuous-Duty 1/2-2hp O.D.P.-Standard T.E.F.C.-Optional	Relay	115/230V, 1-Phase 230/460V, 3-Phase	Jackshaft-Standard Trolley-Standard	Standard	2-Years
PowerHoist™ STANDARD	Jackshaft or Trolley	30/hr	Belt	1-Standard 12-Dust 7-Explosion 9-Explosion	Continuous-Duty 1/3-3/4hp O.D.P.-Standard T.E.F.C.-Optional	Relay	115/230V, 1-Phase 230/460V, 3-Phase	Jackshaft-Standard Trolley-Optional*	Optional	2-Years
PowerHoist™ BASIC	Jackshaft or Trolley	12/hr	Belt	1-Standard	Intermittent-Duty 1/2hp	Relay	115V	Jackshaft-Standard Trolley-Optional	Optional	2-Years

Raynor offers a complete line of commercial sectional doors, and also commercial rolling and fire doors and traffic doors.



P.O. Box 448, 1101 East River Road, Dixon, IL 61021



CLICK

[www.raynor.com](http://www.raynor.com)

CALL

1-800-4-RAYNOR

FAX

1-815-288-7142

Exclusively Distributed By:

This information was as complete and factual as possible at the time it was printed. We do, however, reserve the right to make changes in product specifications and availability without notice. Features and options may be different in countries other than the United States. Product colors have been reproduced as well as possible with present commercial printing processes. For absolute accuracy in color matching, use actual product samples.